

20 Gallon Fog Unit

Operation Manual

FG-20N-3

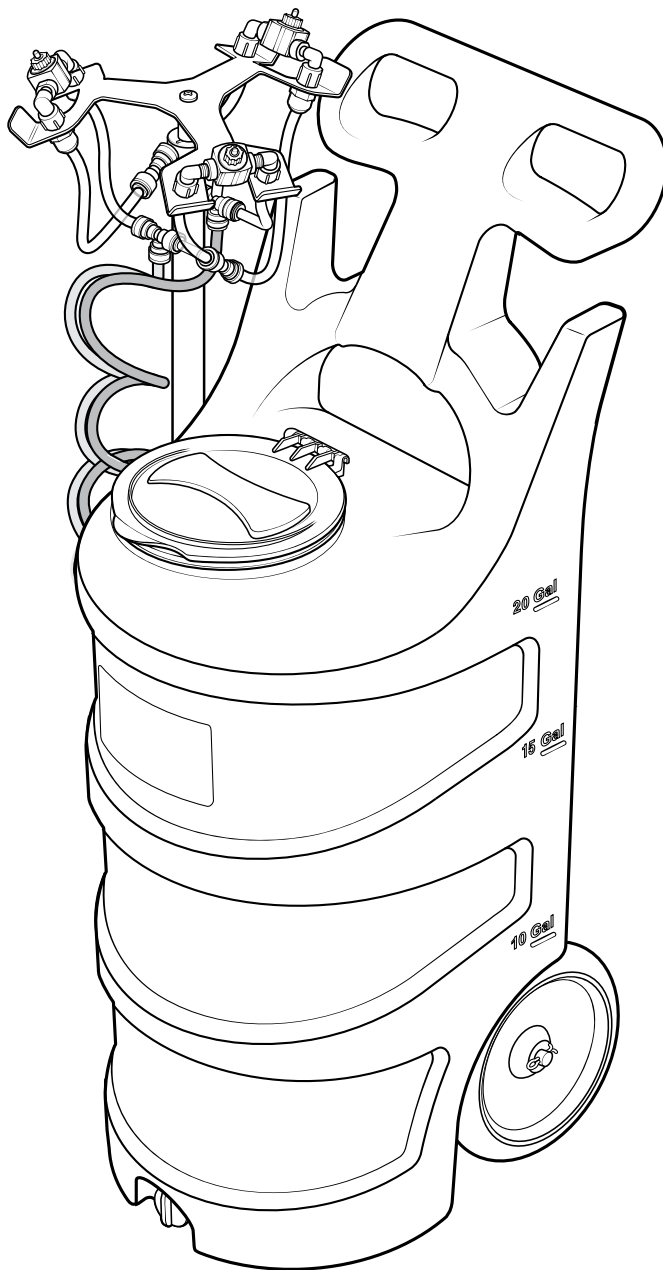

READ ALL INSTRUCTIONS BEFORE USING OR
SERVICING THIS UNIT. KEEP THIS MANUAL IN A
LOCATION THAT IS READILY AVAILABLE TO USERS
AND SERVICE TECHNICIANS.

English (Original Instructions)



Scan this code for
operation manual



Safety

WARNING

PEOPLE OR OBJECTS CAN BE HURT OR DAMAGED IF THIS UNIT IS NOT USED CORRECTLY!



Failure to read all the instructions before operating the unit may result in personal injury or death from the improper use or the chemical solution. Anyone handling, operating or using the unit must read and understand the instructions in the manual. The buyer assumes all responsibility for safety and proper use in accordance with the instructions.



Using or servicing the unit without appropriate personal protective equipment (PPE) may result in serious injury such as burns, rashes, eye, throat or lung damage and death. Always wear PPE as indicated in the Safety Data Sheet (SDS) when using or servicing the unit. Protect eyes, skin, and lungs against drifting spray.



Chemical solutions may pose a health risk and death if they contact the skin or eyes, are inhaled or swallowed. Always read and follow all chemical safety precautions and handling instructions provided by the chemical manufacturer and the SDS associated with the chemical solution before using the unit.



Pressure within the equipment may cause an unexpected release of the chemical solution and cause serious injury such as burns, rashes, eye damage, throat or lung damage and death. Always depressurize and clean the unit after each use. Never leave the unit unattended while pressurized.

Using the unit with fluid temperatures above 100°F (37.8°C) may result in scalding, burns, serious injury or death. **DO NOT** use a solution with a temperature above 100°F (37.8°C).

Operating the unit when damaged or leaking may result in exposure to chemical solutions, serious injury or death. Never use the unit if it is damaged or leaking.

Never point the discharge wand at yourself, another person, or any object you do not want covered in chemical.



Using incoming air pressure exceeding 100 psi (6.9 bar) may result in pressure buildup, explosion, serious injury or death. **DO NOT** exceed 100 psi (6.9 bar) incoming air pressure when operating the unit.

Use of hydrocarbons and flammable products may result in explosions, fire and serious injury or death. Never use hydrocarbons or flammable products with the unit.



Mixing an alkaline with an acid may result in a chemical reaction. Overheating of the mixture may cause it to splatter caustic compounds or release hazardous fumes, gas and vapors. Always flush the unit with fresh water thoroughly when switching from an alkaline to an acid or an acid to an alkaline.

NOTICE

Servicing or modifying this unit with parts not listed in this manual may cause the unit to operate improperly. Do not use unauthorized parts when servicing the unit.

Use of an air lubricator before the unit may result in diminished performance and damage to the unit. Do not use an air lubricator before the unit.

Moisture in the air lines will damage the pump and diminish the pump life. The air must be filtered, clean, dry and free of moisture. If needed, install an air dryer before the unit.

PROTECT THE ENVIRONMENT



Please dispose of packaging materials, old machine components, and hazardous fluids in an environmentally safe way according to local waste disposal regulations

Product Overview

Requirements

Compressed air requirements	50 psi (3.4 bar) with 9 CFM (254.9 l/min)
Liquid temperature range	40-100°F (4.4-37.8°C)
Chemical compatibility	Chemical products used with this equipment must be formulated for this type of application and compatible with unit materials and pump seals. For more information on chemical compatibility, consult the manufacturer or SDS for your product or contact our customer service department.

Specifications

Power type	Compressed air
Chemical pickup type	Draws from pre-mixed solution
Number of products unit can draw from	One product
Suction line diameter	3/8 in. (9.5 mm) inside diameter
Capacity	20 gallons (75.7 liters)
Flow rate*	3.7 gal/hour at each nozzle
Pump seals	Santoprene, Viton, or Kalrez
Droplet size	15 microns at 50 psi
Coverage area**	1 liter of solution will cover approximately 1000 cubic feet (up to system max of 47,320 cubic feet)
Run time from full tank**	Approx. 1 hour
Number of nozzles	3 nozzles
Mast height range	3.5-8.5 ft. (1.1-2.6 m)
Wheel type	Two 10 inch (25.4 cm) non-marking wheels.

*Dilution rates and flow rates given are based on chemical with viscosity of water and factory air pressure settings.

**Area covered and run time may vary based on humidity, air flow, and product used.

Product Components

Get to know the FG-20N-3 components that you will need to use, adjust, or assemble.

Back plate assembly • Inside view

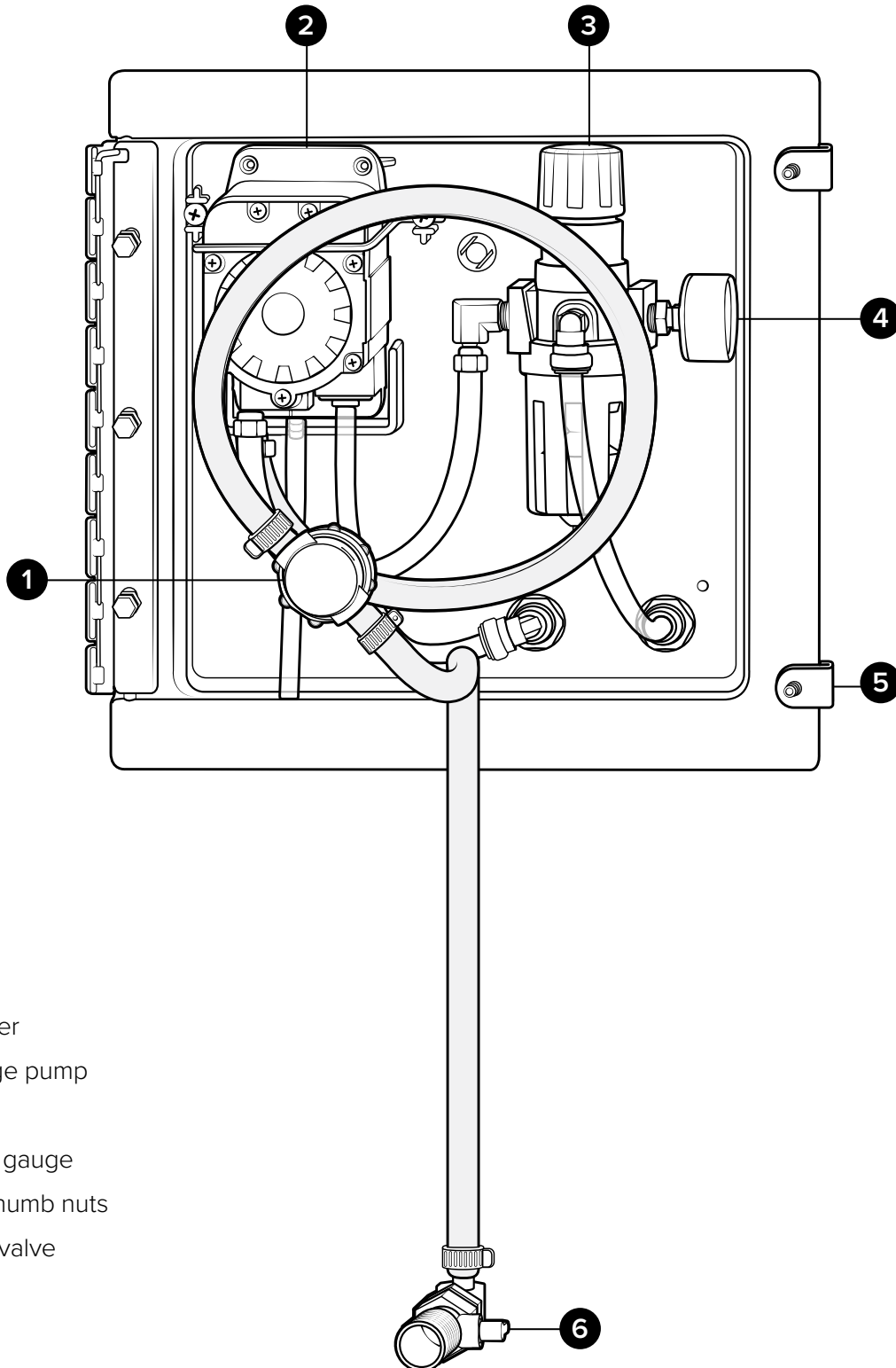

1. In-line strainer
2. Quick-change pump
3. Air regulator
4. Air pressure gauge
5. Back plate thumb nuts
6. Suction line valve

Tank Assembly

Front view

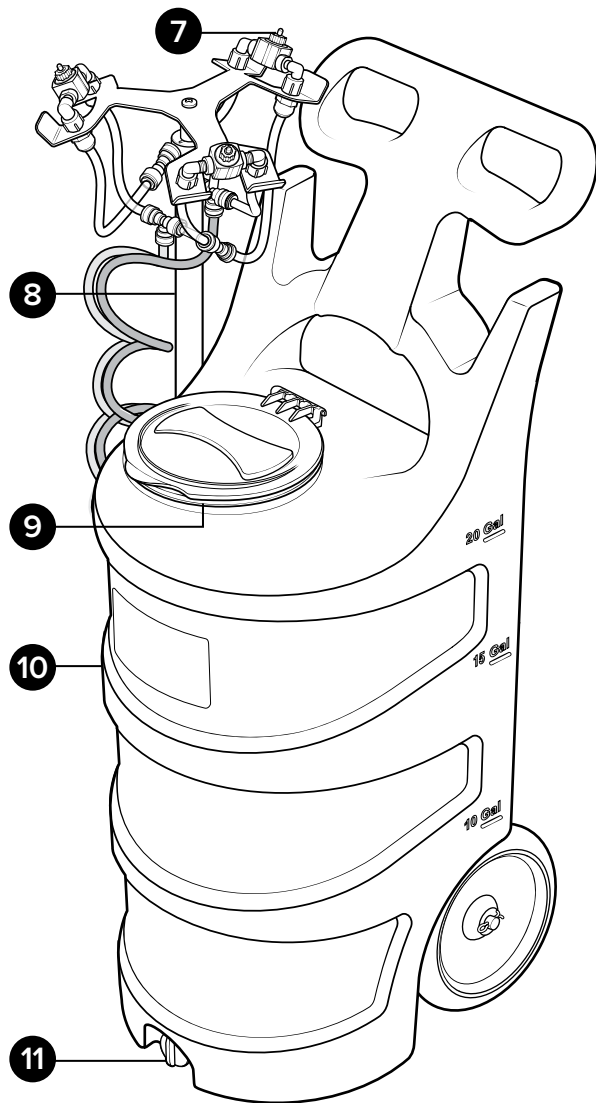

Back view

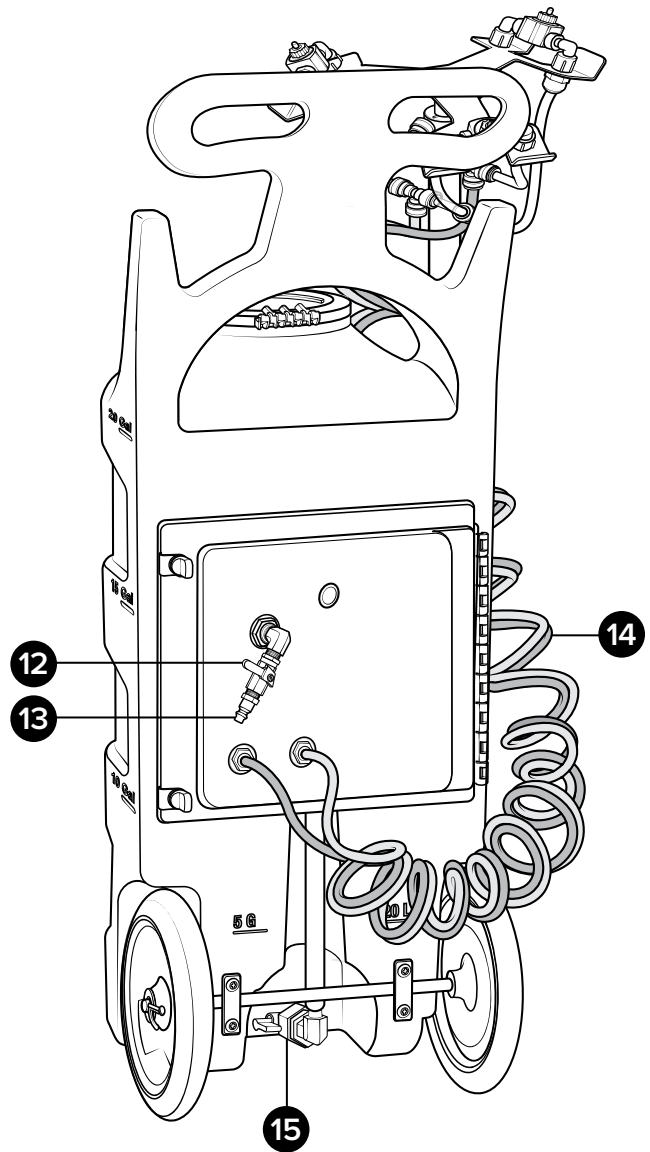

- 7. Fog nozzle
- 8. Mast
- 9. Hinged lid
- 10. Solution tank
- 11. Drain plug
- 12. Air inlet valve
- 13. Air fitting
- 14. Coiled twin line tubing
- 15. Suction line valve

Using your unit

Assembly Instructions

1. Using the screw (provided) attach fog nozzle assembly to the top of the fog mast.

Note: The fog nozzles should point upwards.

2. Connect the red tube to the RED coded T-fitting on the fog nozzle assembly.
3. Connect the blue tube to the BLUE coded T-fitting on the fog nozzle assembly.
4. Push one end of the blue tube into the fitting next to the BLUE arrow on the unit's back plate.
5. Push one end of the red tube into the fitting next to the RED arrow on the unit's back plate.

Note: Make sure to insert the tubing all the way into the fittings to ensure proper connection.

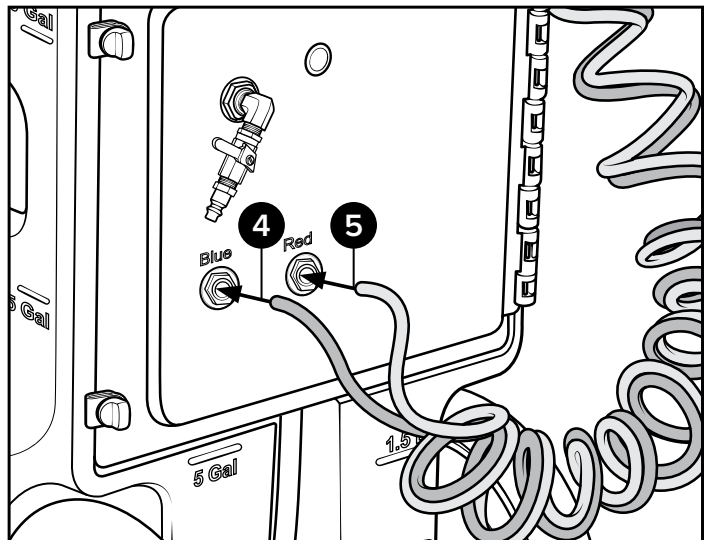
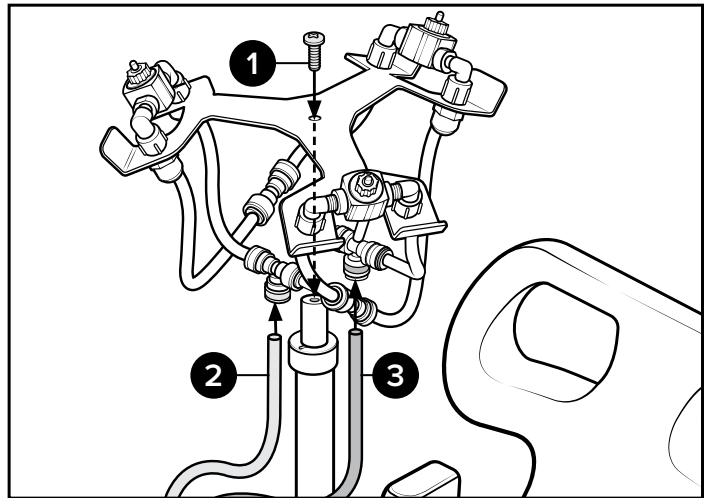

Using your unit

Operating Instructions

Note: Always follow all chemical safety precautions and handling instructions provided by the chemical manufacturer and Safety Data Sheet (SDS).

1. Verify drain plug is securely closed.
2. Fill solution tank with pre-mixed solution.
3. Place the unit in the area to be fogged.
4. If needed, adjust the mast by:
 - Loosening the collar screws
 - Adjusting the mast to the desired height
 - Re-tighten the collar screws to secure

Caution: To prevent injury from collapsing mast, always support the mast when adjusting height. Ensure collar screws are tight and secure before releasing the mast.

5. Ensure the suction line valve at the base of the suction line is open to allow fluid flow.
6. Confirm air inlet valve is in the closed position.
7. Connect an air line to the air inlet fitting.
8. Open the air inlet valve to activate the unit.
9. Evacuate the area.
10. After the unit has stopped fogging, observe all appropriate safety precautions before reentering the area.
11. Close the air inlet valve and disconnect the air line from the unit.

After Use Instructions

12. Before moving the unit, always lower the mast completely and secure it in the lowest position.
13. Disconnect the air line from the air fitting.
14. Open the air inlet valve to relieve all remaining pressure from the unit.
15. Close the air inlet valve after all pressure has been relieved. Store unit with inlet valve closed.
16. Before using the unit with another chemistry, thoroughly flush with water.

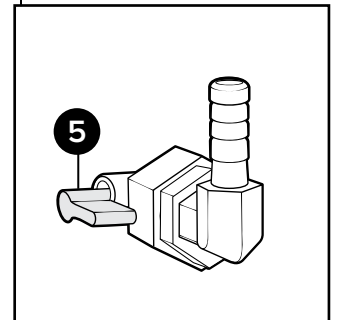
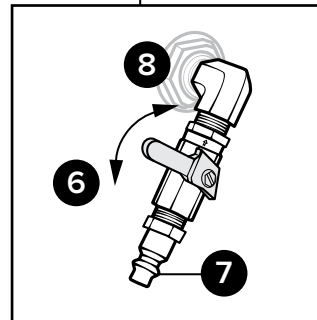
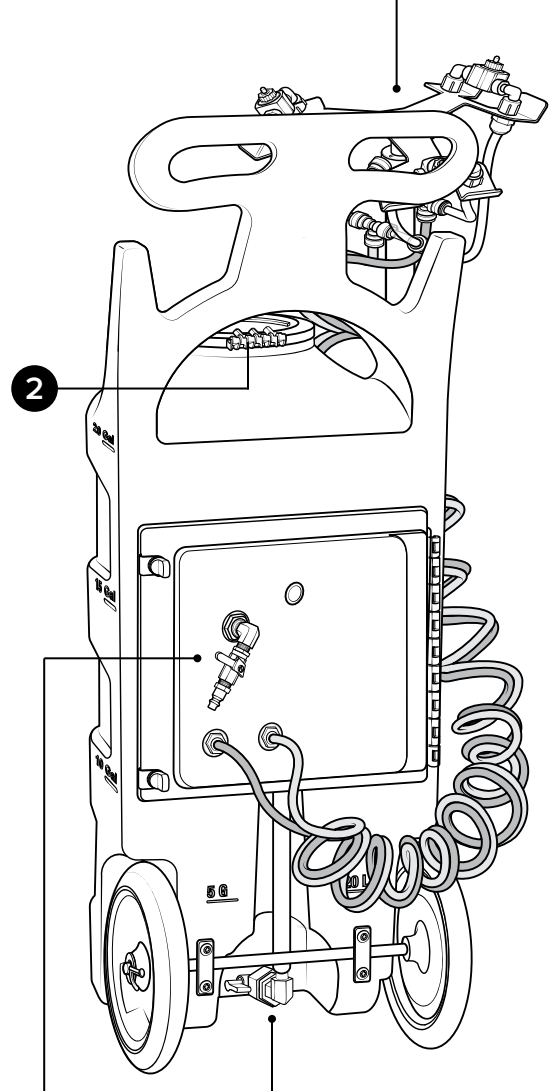
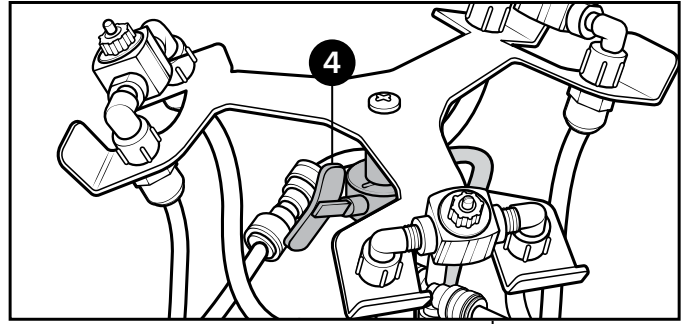

Maintenance

WARNING

Performing any maintenance with the unit pressurized, and connected to the air supply may result in serious injury or death. Always ensure that the unit has been depressurized, and disconnected from the air supply before conducting any maintenance. Servicing or modifying this unit with parts not listed in this manual may cause the unit to operate improperly. Do not use unauthorized parts when servicing the unit.

Maintaining Your Unit

To keep your unit operating properly, periodically perform the following maintenance procedures:

- Inspect the pump for wear and leaks.
 - Inspect all hoses for leaks or excessive wear.
 - Ensure all hose clamps are in good condition and properly secured.
 - Check suction line and strainer for debris. Clean as needed.
 - Inspect nozzles for debris. Clean as needed.
 - Drain your air compressor tank on a regular basis to help extend pump life. An air source with a high moisture content will accelerate pump wear.
- Note:** If your air source has a high moisture content, install a water separator to the air fitting on the backplate.

Servicing Your Unit

To service your unit, refer to the service manual which includes:

- Troubleshooting procedures.
- Detailed parts breakdowns and illustrations.
- Part numbers of serviceable components and assemblies.



Scan this code for
service manual

